

Technical data Corode CS vertical pump

CS300-037 PP/ PVDF

Materials available	:PP or PVDF
O-ring	:EPDM or Viton
Max. flow	:8.7m ³ /h
Max. head	:10.8m.
Max. temperature	:PP 75°C; PVDF 90°C
Motor	:0.37kW, 400V, 1.63/0.94Amp, 3Ph, 50Hz, IP55

CS300-037

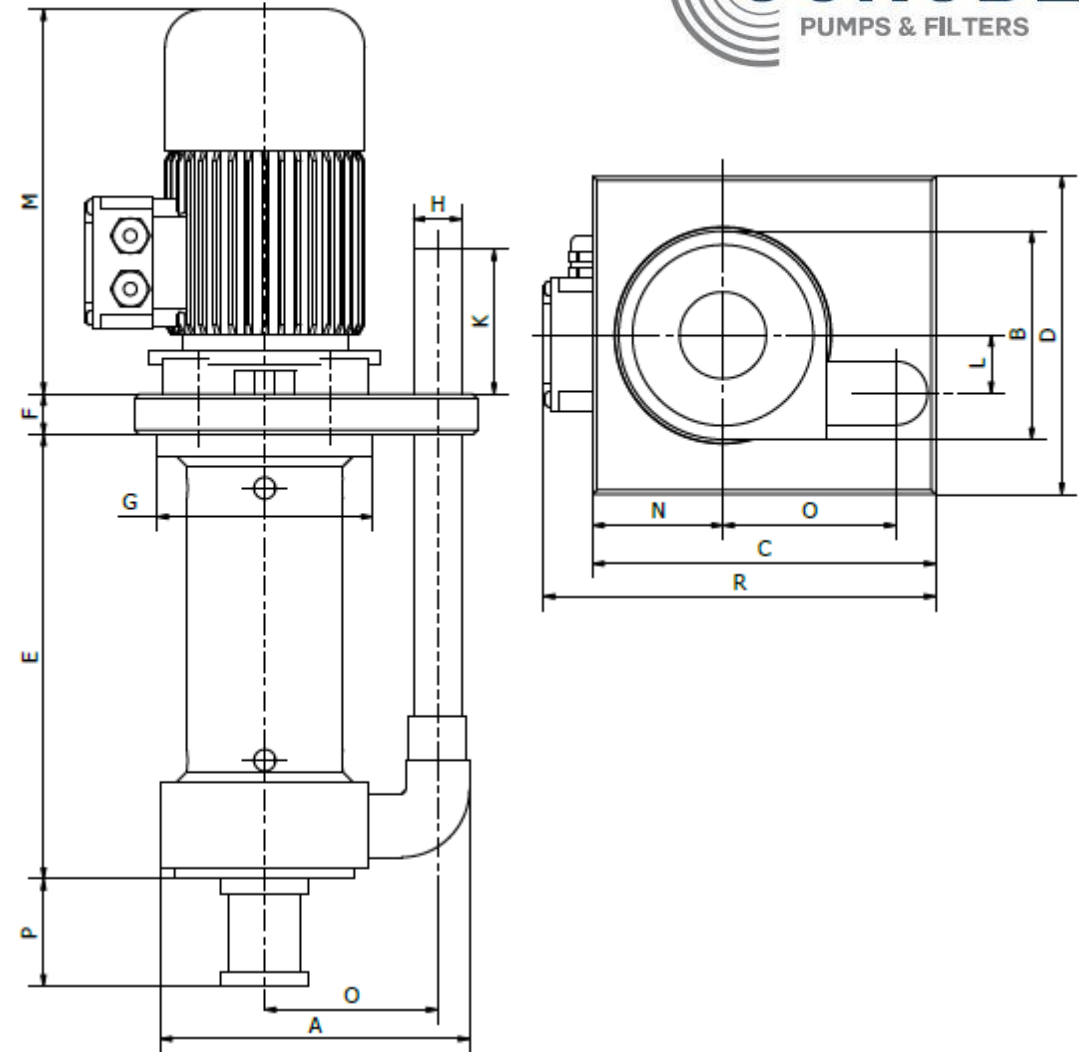
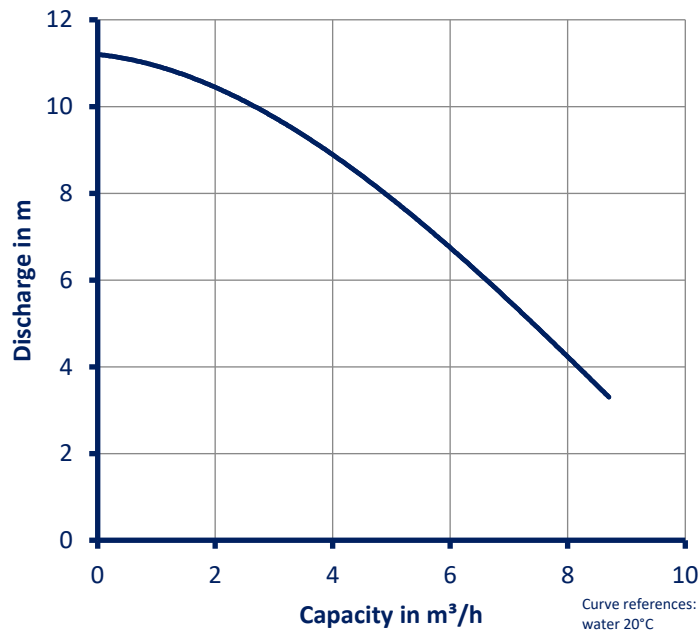

	A	B	C	D	E	F	G	H	K	L	M	N	O	P	R
CS300-037	205	144	227	220	305	25	150	32	95	40	230	90	110	70	245

www.corode.eu

tel: +31 (0)161-244250

corode@corode.nl